



UM18-217126112

UM18

ULTRASONIC SENSORS

SICK
Sensor Intelligence.



Ordering information

Type	Part no.
UM18-217126112	6048387

Other models and accessories → www.sick.com/UM18



Detailed technical data

Performance

Working range, limiting range	20 mm ... 150 mm, 250 mm
Resolution	≥ 0.069 mm
Repeatability	± 0.15 % ¹⁾
Accuracy	± 1 % ^{1) 2)}
Temperature compensation	✓
Response time	32 ms ³⁾
Output time	8 ms
Ultrasonic frequency (typical)	380 kHz
Detection area (typical)	See diagrams
Additional function	Teach-in of analog output, Invertable analog output, temperature compensation, multifunctional input: external teach / synchronization / multiplexing, synchronization of up to 10 sensors, multiplexing: no cross talk of up to 10 sensors, reset to factory default ⁴⁾

¹⁾ Referring to current measurement value.

²⁾ Temperature compensation can be switched off, without temperature compensation: 0.17 % / K.

³⁾ Subsequent smoothing of the analog output, depending on the application, may increase the response time by up to 200 %.

⁴⁾ Functions may vary depending on sensor type.

Interfaces

Analog output	1 x 4 mA ... 20 mA (≤ 500 Ω) ¹⁾
Resolution analog output	12 bit
Multifunctional input (MF)	1 x MF

¹⁾ For 4 mA ... 20 mA and $V_s \leq 20$ V max. load ≤ 100 Ω.

Mechanics/electronics

Supply voltage V_s	DC 10 V ... 30 V ^{1) 2)}
Power consumption	≤ 1.2 W ³⁾
Initialization time	< 300 ms

¹⁾ Limit values, reverse-polarity protected, operation in short-circuit protected network: max. 8 A.

²⁾ 15 V ... 30 V when using the analog voltage output.

³⁾ Without load.

Design	Cylindrical
Housing material	Nickel-plated brass Ultrasonic transducer: polyurethane foam, glass epoxy resin
Connection type	Male connector, M12, 5-pin
Indication	2 x LED
Weight	30 g
Sending axis	Angled

1) Limit values, reverse-polarity protected, operation in short-circuit protected network: max. 8 A.

2) 15 V ... 30 V when using the analog voltage output.

3) Without load.

Ambient data

Enclosure rating	IP 67
Protection class	III
Ambient temperature	Operation: -25 °C ... +70 °C Storage: -40 °C ... +85 °C

Dimensional drawing (Dimensions in mm (inch))

UM18-2xxxxx2

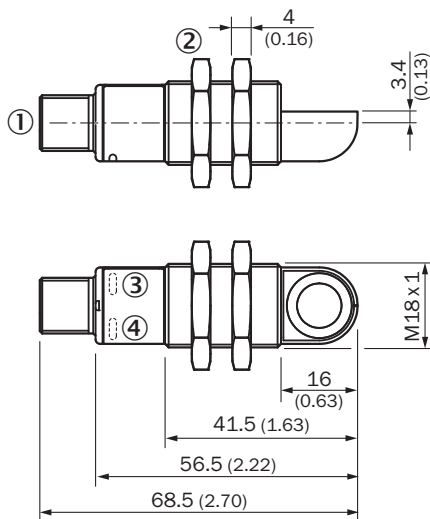

- ① Connection
- ② Mounting nuts, SW 24 mm
- ③ Status indicator operating voltage active (green)
- ④ Status indicator switching/analog output (orange)

Connection type

Male connector M12, 5-pin



Connection diagram

UM18-21xxx6xxx UM18-21xxx7xxx Connector M12, 5-pin

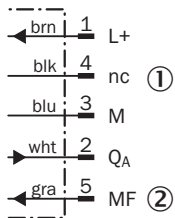

① Not assigned

② Multifunctional input/synchronization and multiplex operation/communication Connect+

Detection area

UM1x-x17

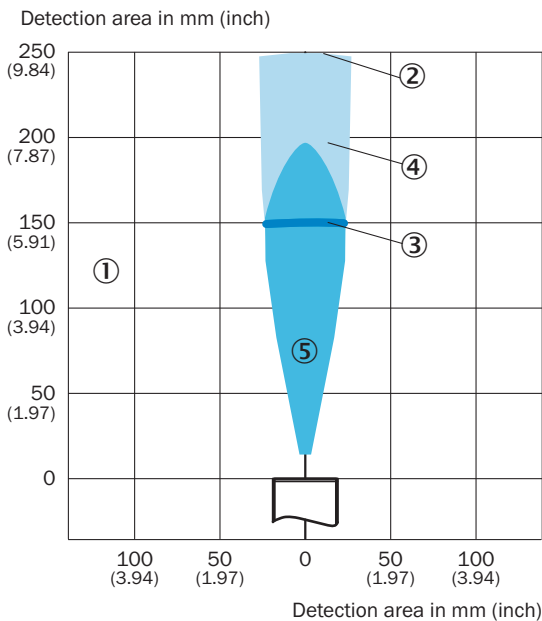

① Sensing range dependent on reflection properties, size and orientation of the object

② Limiting range

③ Working range







④ Example object: aligned plate 500 mm x 500 mm

⑤ Example object: pipe with 10 mm diameter

Recommended accessories

Other models and accessories → www.sick.com/UM18

	Brief description	Type	Part no.
Universal bar clamp systems			
	Plate H for universal clamp bracket, steel, zinc coated, universal clamp and mounting hardware included	BEF-KHS-H01	2022465

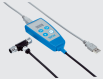
	Brief description	Type	Part no.
Mounting brackets and mounting plates			
	Mounting plate for M18 sensors, steel, zinc coated, without mounting hardware	BEF-WG-M18	5321870
	Mounting bracket, M18 thread, steel, zinc coated, without mounting hardware	BEF-WN-M18	5308446
Terminal and alignment brackets			
	Mounting bracket with ball-and-socket, plastic, mounting hardware included	BEF-WN-M18-ST02	5312973
	Clamping block for round sensors M18, with fixed stop, plastic (PA12), glass-fiber reinforced, mounting hardware included	BEF-KHF-M18	2051482
Plug connectors and cables			
	Head A: female connector, M12, 5-pin, straight Head B: cable Cable: PVC, unshielded, 2 m	DOL-1205-G02M	6008899
	Head A: female connector, M12, 5-pin, angled Head B: cable Cable: PVC, unshielded, 2 m	DOL-1205-W02M	6008900
Programming and configuration tools			
	Tool for visualization, configuration and cloning, 3-digit LED display, supply voltage: DV 9 V ... 30 V	Connect+ adapter (CPA)	6037782

SICK AT A GLANCE

SICK is one of the leading manufacturers of intelligent sensors and sensor solutions for industrial applications. A unique range of products and services creates the perfect basis for controlling processes securely and efficiently, protecting individuals from accidents and preventing damage to the environment.

We have extensive experience in a wide range of industries and understand their processes and requirements. With intelligent sensors, we can deliver exactly what our customers need. In application centers in Europe, Asia and North America, system solutions are tested and optimized in accordance with customer specifications. All this makes us a reliable supplier and development partner.

Comprehensive services complete our offering: SICK LifeTime Services provide support throughout the machine life cycle and ensure safety and productivity.

For us, that is “Sensor Intelligence.”

WORLDWIDE PRESENCE:

Contacts and other locations –www.sick.com